



NORTEC

RF Products

3dB, 90° High Power Hybrid Coupler

Model #: HH20090000

Electrical Specifications

Frequency: 0.8– 1.0 GHz
Average Power: 500 Watts (**max**)
Amplitude Balance: +/- 0.25 dB
Insertion Loss: 0.2 dB (max)
Isolation: 25 dB (**typ**)
Phase Balance: 90 +/- 1.0°
VSWR: 1.15:1 (**max**) (Nominal 50 Ohm all ports)

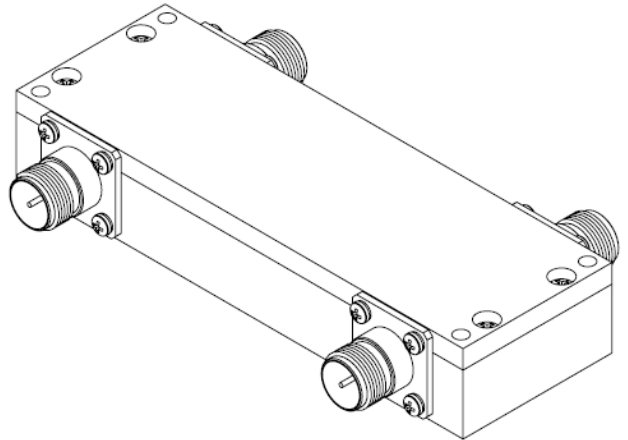

Mechanical Specifications

Connectors: N(F), Nickel plated Brass
Connector Insulator: PTFE
Connector Pin: Gold plated Beryllium Copper
Enclosure: Aluminum – clear irridite per MIL-C-5541 class 3

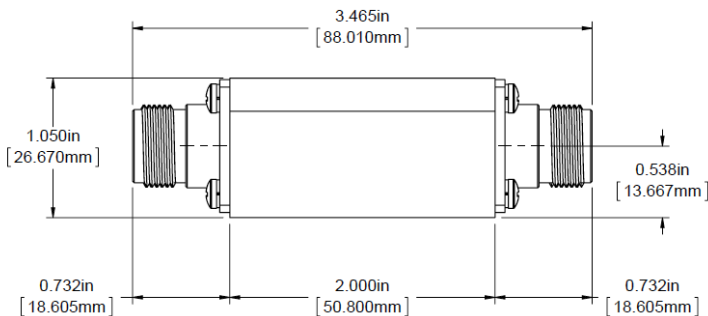
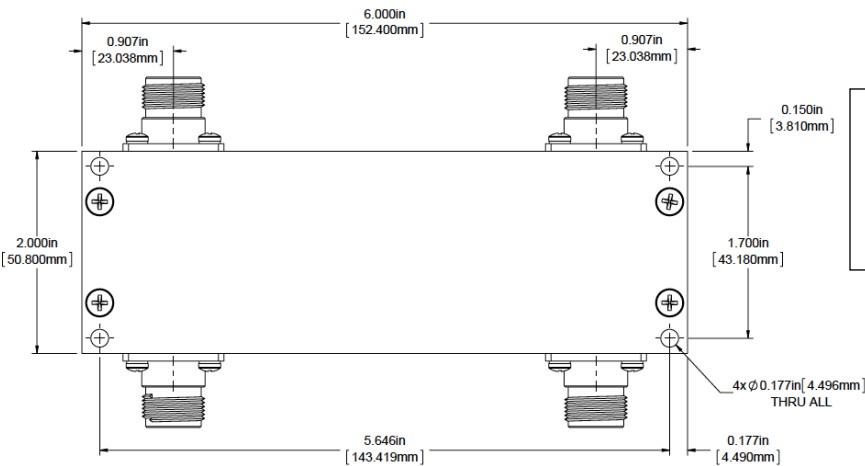

Notes:

- All ports are assumed to be terminated with 50 Ohm loads.
- When used at full power, heat sink mounting is required.
- **Operating temperature** is -35° C to 85° C