



NORTEC

RF Products

3dB, 90° Hybrid Coupler

Model #: H100185000

Electrical Specifications

Frequency: 1.7-2.0 GHz

Average Power: 150 Watts (**max**)

Amplitude Balance: +/- 0.35 dB (**max**)

Insertion Loss: 0.35 dB (**max**)

Isolation: 20 dB (**typ**)

Phase Balance: 90 +/- 1°

VSWR: 1.3:1 (**max**) (Nominal 50 Ohm all ports)

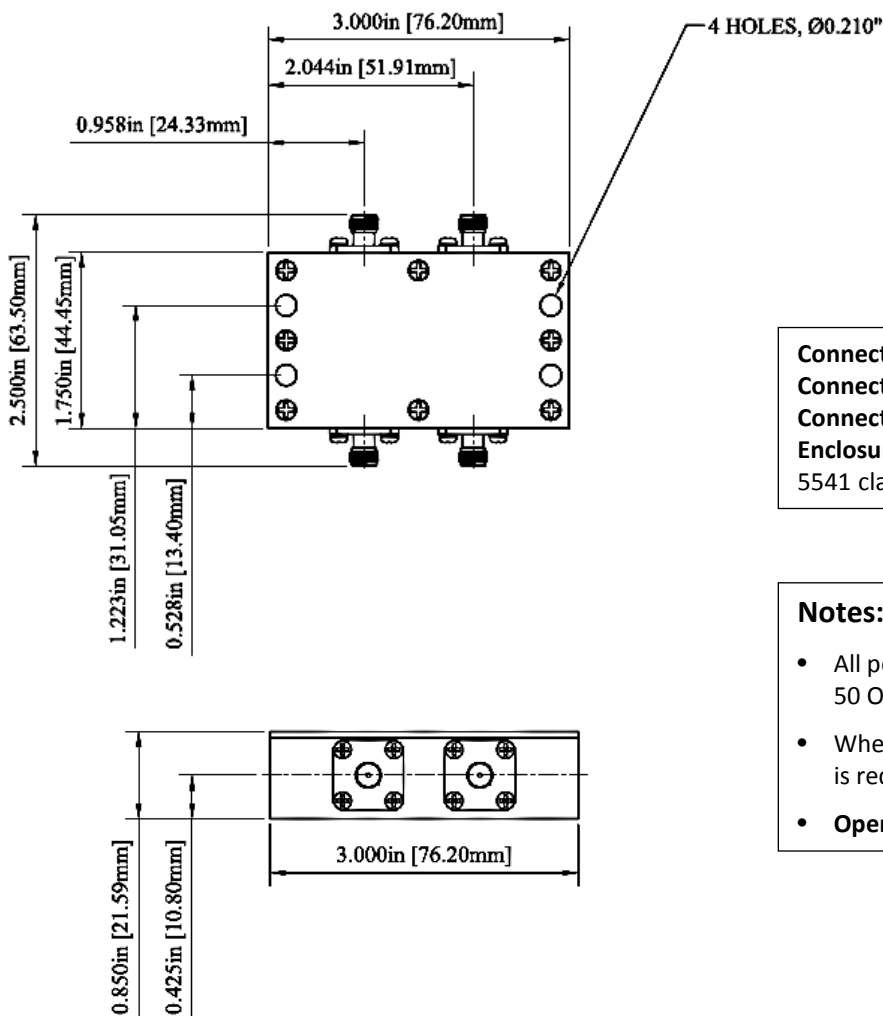
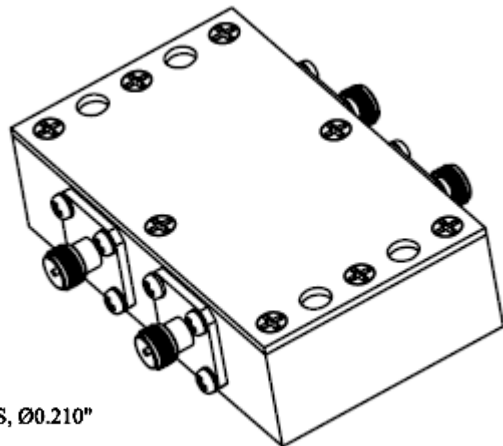

Connectors: SMA (F), Nickel plated Brass
Connector Insulator: PTFE
Connector Pin: Gold plated Beryllium Copper
Enclosure: Aluminum – clear irridite per MIL-C-5541 class 3

Notes:

- All ports are assumed to be terminated with 50 Ohm loads.
- When used at full power, heat sink mounting is required.
- **Operating temperature** is -35° C to 85° C