



NORTEC

RF Products

Uni Directional Coupler

Model #: D230090000

Electrical Specifications

Frequency: 600-1200 MHz
Average Power: 250 Watts (**max**)
Coupling: 30 dB +/- 0.75 dB
Frequency Sensitivity: +/- 1.25 dB
Insertion Loss: 0.15 dB (**max**), 0.1 dB (**typ**)
Directivity: 24 dB (**typ**)
Main Line VSWR: 1.15:1 (**max**) (50 Ohm all ports)

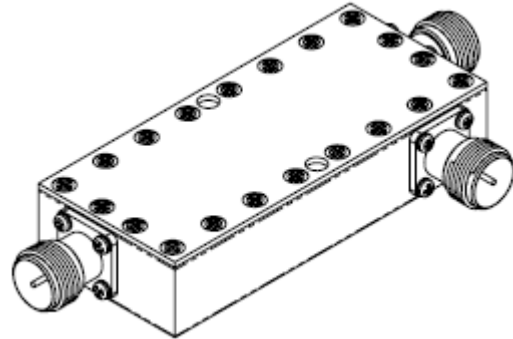

Mechanical Specifications

Connectors: N (F), Nickel plated Brass
Connector Insulator: PTFE
Connector Pin: Gold Plated Beryllium Copper
Enclosure: Aluminum – clear irridite per MIL-C-5541 class 3

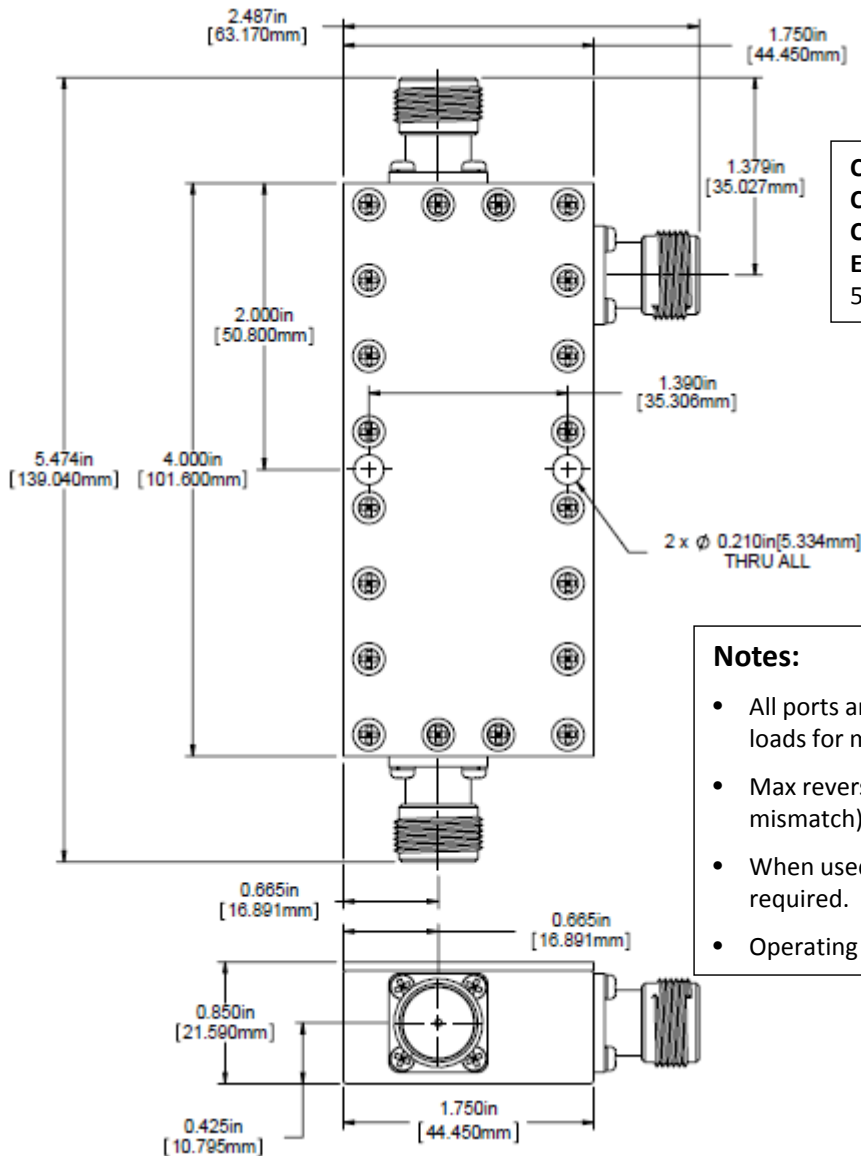

Notes:

- All ports are assumed to be terminated with 50 Ohm loads for max. forward power rating.
- Max reverse power = 5 W. (with output load mismatch)
- When used at full power, heat sink mounting is required.
- Operating temperature is -35° C to 85° C