



NORTEC

RF Products

Uni Directional Coupler

Model #: D220075000

Electrical Specifications

Frequency: 500-1000 MHz

Average Power: 100 Watts (**max**)

Coupling: 20 dB +/- 0.75 dB

Frequency Sensitivity: +/- 1.25 dB

Insertion Loss: 0.15 dB (**max**), 0.1 dB (**typ**)

Directivity: 24 dB (**typ**)

Main Line VSWR: 1.15:1 (**max**) (50 Ohm all ports)

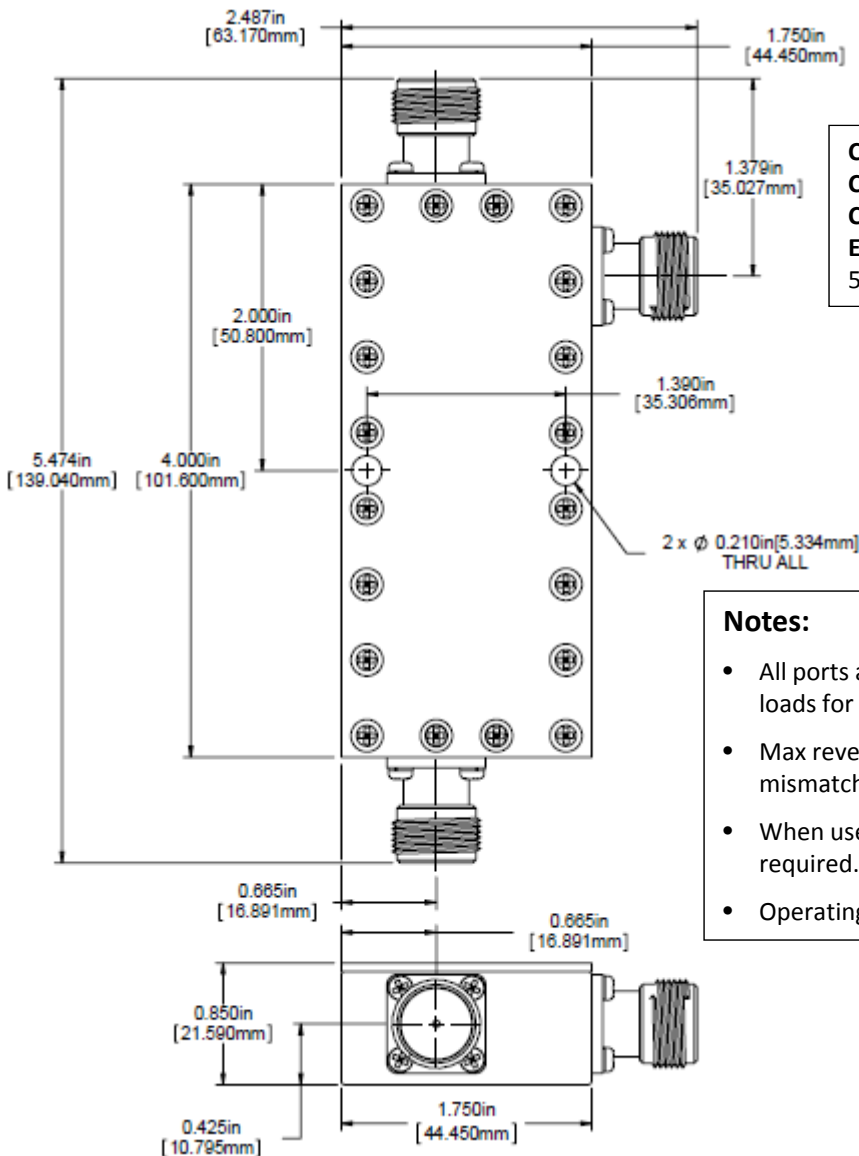
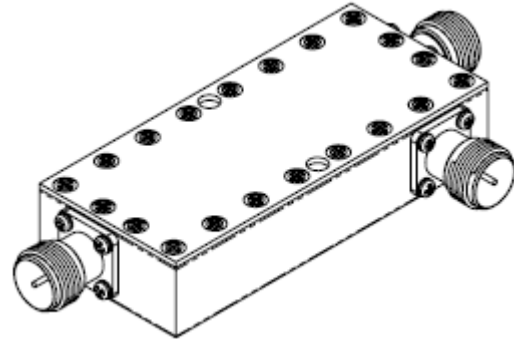

Mechanical Specifications

Connectors: N (F), Nickel plated Brass

Connector Insulator: PTFE

Connector Pin: Gold Plated Beryllium Copper

Enclosure: Aluminum – clear irridite per MIL-C-5541 class 3

Notes:

- All ports are assumed to be terminated with 50 Ohm loads for max. forward power rating.
- Max reverse power = 5 W. (with output load mismatch)
- When used at full power, heat sink mounting is required.
- Operating temperature is -35° C to 85° C