



# NORTEC

RF Products

## Uni Directional Coupler

Model #: D210120000

### Electrical Specifications

**Frequency:** 0.8-1.6 GHz

**Average Power:** 50 Watts (**max**)

**Coupling:** 10 dB +/- 0.5 dB

**Frequency Sensitivity:** +/- 1.25 dB

**Insertion Loss:** 0.15 dB (**max**), 0.1 dB (**typ**)

**Directivity:** 24 dB (**typ**)

**Main Line VSWR:** 1.15:1 (**max**) (50 Ohm all ports)

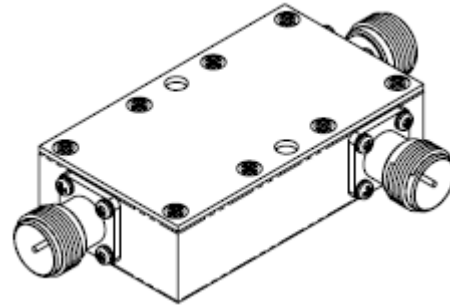

### Mechanical Specifications

**Connectors:** N (F), Nickel plated Brass

**Connector Insulator:** PTFE

**Connector Pin:** Gold Plated Beryllium Copper

**Enclosure:** Aluminum – clear irridite per MIL-C-5541 class 3

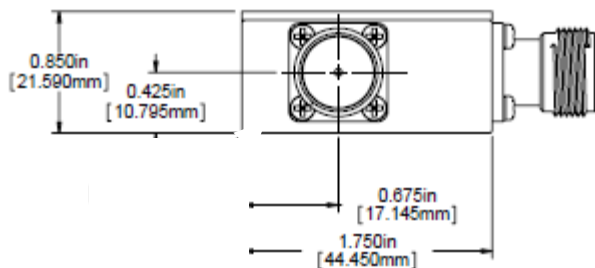
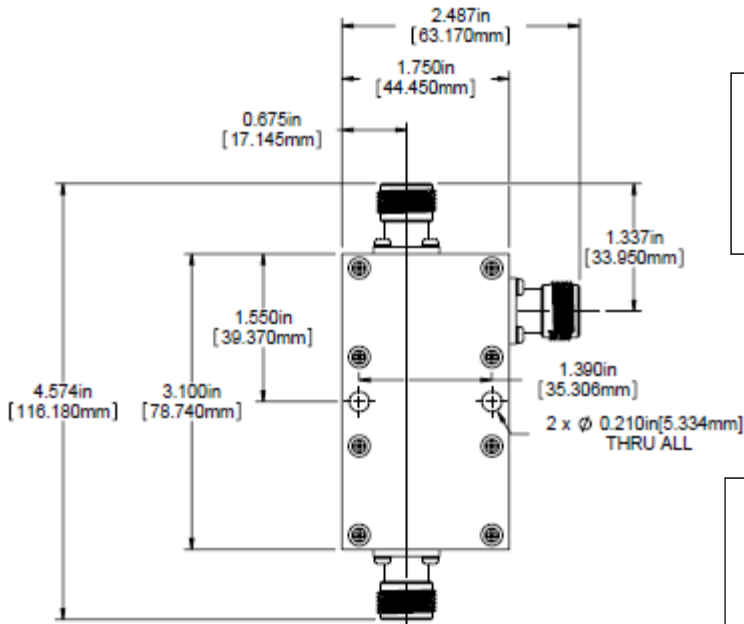

### Notes:

- All ports are assumed to be terminated with 50 Ohm loads for max. forward power rating.
- Max reverse power = 5 W. (with output load mismatch)
- When used at full power, heat sink mounting is required.
- Operating temperature is -35° C to 85° C