



# NORTEC

RF Products

## Dual Directional Coupler

Model #: D230090010

### Electrical Specifications

**Frequency:** 0.6-1.2 GHz

**Average Power:** 250 Watts (**max**)

**Coupling:** 30 dB +/- 1.5 dB

**Insertion Loss:** 0.15 dB (**max**), 0.075 dB (**typ**)

**Directivity:** 23 dB (**typ**)

**Main Line VSWR:** 1.2:1 (**max**) (50 Ohm all ports)

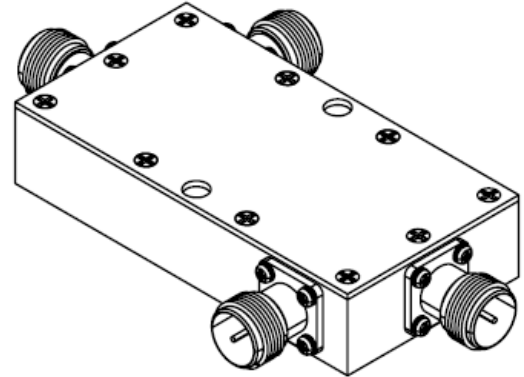

### Mechanical Specifications

**Connectors:** N (F), Nickel plated Brass  
**Connector Insulator:** PTFE  
**Connector Pin:** Gold Plated Beryllium Copper  
**Enclosure:** Aluminum – clear irridite per MIL-C-5541 class 3

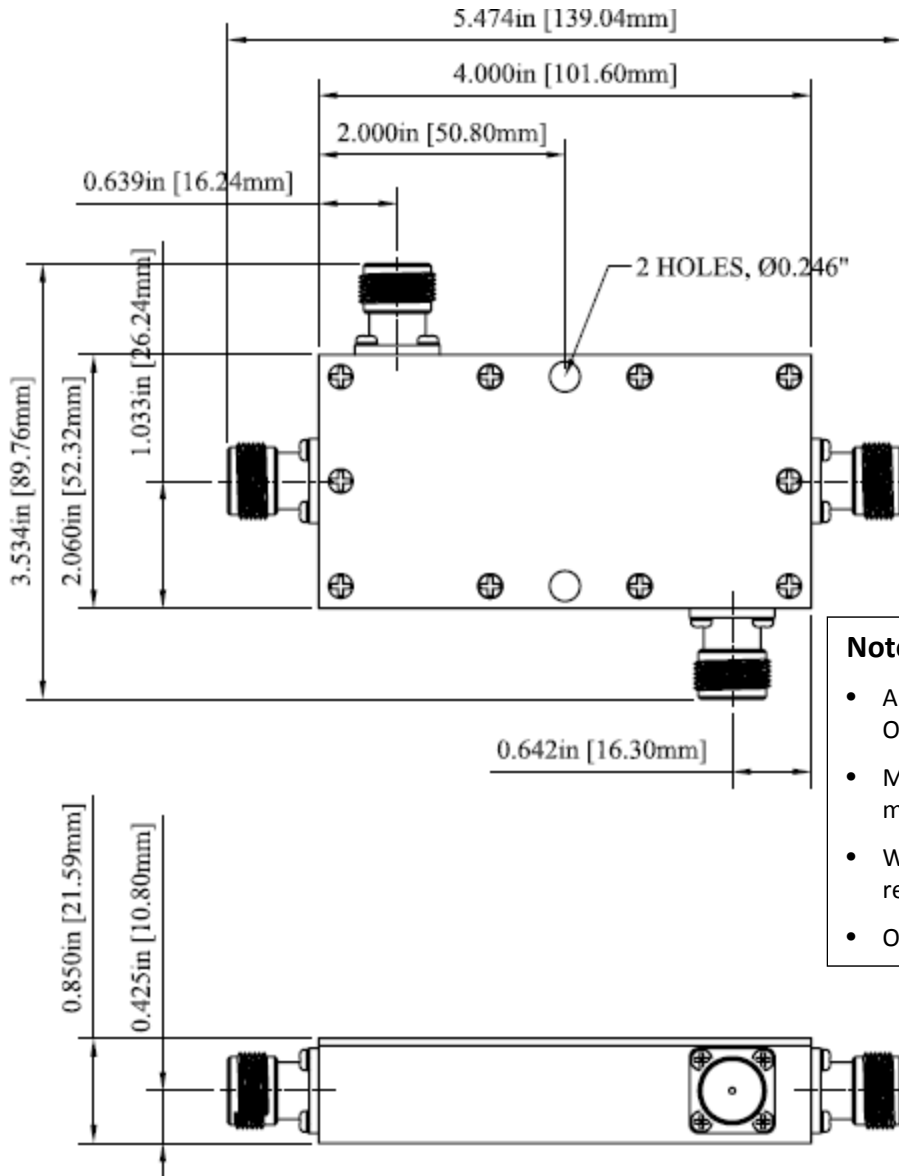

### Notes:

- All ports are assumed to be terminated with 50 Ohm loads for max. forward power rating.
- Max reverse power = 50 W. (with output load mismatch)
- When used at full power, heat sink mounting is required.
- Operating temperature is -35° C to 85° C