



# NORTEC

RF Products

## Electrical Specifications

**Frequency:** 350-750 MHz  
**Average Power:** 250 Watts (**max**)  
**Coupling:** 30 dB +/- 1.5 dB  
**Insertion Loss:** 0.1 dB (**max**), 0.05 dB (**typ**)  
**Directivity:** 24 dB (**typ**)  
**Main Line VSWR:** 1.15:1 (**Typ**) (50 Ohm all ports)

## Dual Directional Coupler

Model #: D230055010

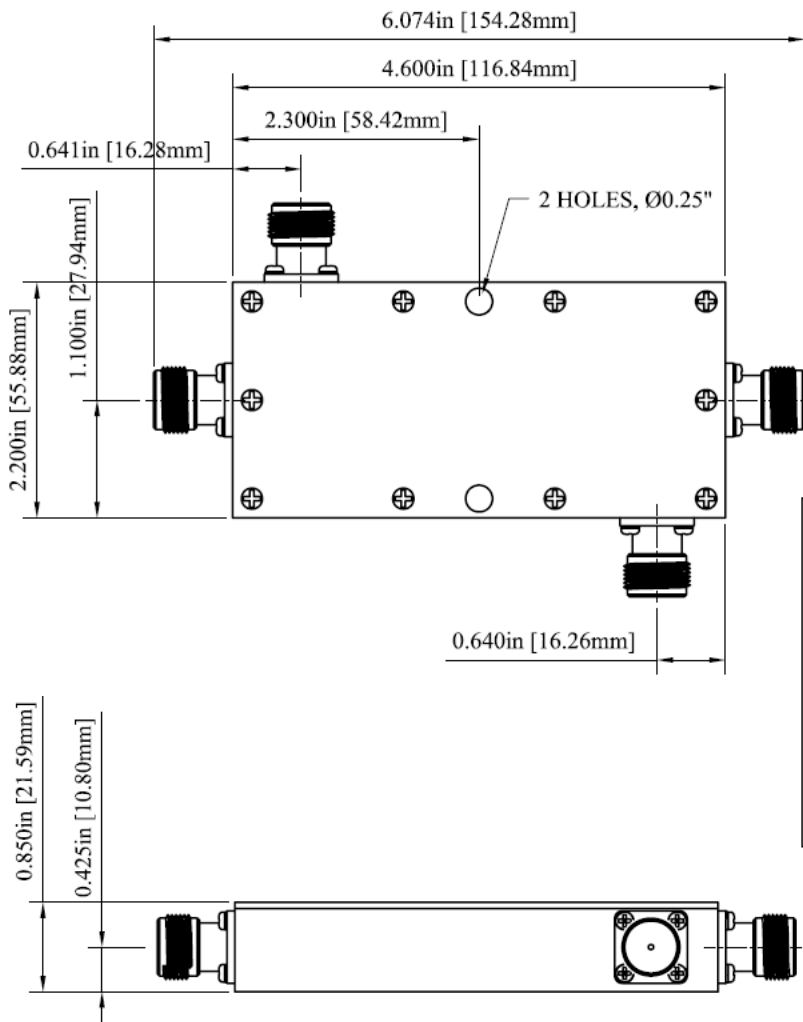
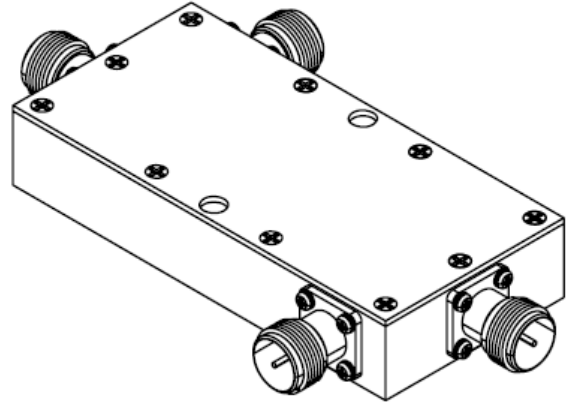

## Mechanical Specifications

**Connectors:** N (F), Nickel plated Brass  
**Connector Insulator:** PTFE  
**Connector Pin:** Gold Plated Beryllium Copper  
**Enclosure:** Aluminum – clear irridite per MIL-C-5541 class 3

## Notes:

- All ports are assumed to be terminated with 50 Ohm loads for max. forward power rating.
- Max reverse power = 50 W. (with output load mismatch)
- When used at full power, heat sink mounting is required.
- Operating temperature is -35° C to 85° C